



# Laminate

# Laminate Flooring Installation Guide

## General Instructions

Mannington Laminate Floors provides a full line of laminate flooring products in various styles, decors, and product constructions. The information contained in this chapter is relevant and pertinent to all Mannington Laminate Flooring products. A thorough understanding and careful consideration of these installation guidelines will contribute to a successful installation. Be certain to review page 4 for information on subfloor selection and preparation.

## Storage and Handling

 **NOTE:** Open cartons just prior to installation.

When storing pallets, do not stack them more than three high, and make certain they are protected from forklift trucks or other traffic. Also during storage, carefully protect package corners and lay boxes horizontally. The storage area must be climate controlled with a temperature range between 65°F and 100°F (18°C and 32°C) and a relative humidity in the 40% to 65% range.



*Always handle cartons carefully so you will not damage the product inside. Always store flooring horizontally in the original, unopened package. Do not puncture packaging. Cartons should not be opened until time of installation. Even if packaging is opened a few days before installation, atmospheric conditions may permanently alter the product, thus making it more difficult to install.*



*Wipe planks with a soft cloth and thoroughly inspect before installation. Mannington Laminate Floors does not cover claims for repair labor or replacement when a plank with visual defects has been permanently installed.*

## Job Site Conditions

Although not required for glueless laminate, for best results condition the unopened cartons for approximately 48 hours in the area where the floor will be installed. Job site temperature should be 65°F or higher and the relative humidity should not exceed 65%.

If a single room exceeds 2000 square feet or has a length or width greater than 45 feet, additional expansion joints will be required. This is accomplished by providing a greater than  $\frac{3}{16}$ " amount of expansion at all fixed vertical surfaces. Extra caution must be exercised when transitioning from a larger area to a smaller area. Be certain to maintain adequate expansion in the doorways by using T-moldings and/or undercutting the door frames.

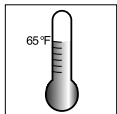

### Temperature Requirements

As with all flooring installations, the site must be climate controlled. The temperature should be at least 65°F and the relative humidity should not exceed 65%. It is particularly important to maintain these temperature and humidity requirements for at least 48 hours before and after installation, as well as during. Furthermore, these conditions must be maintained for the life of the laminate floor product. Never install Mannington Laminate Floors in high-humidity areas where the floor is usually wet (steam rooms, saunas).

# Laminate Flooring Installation Guide (continued)

## Structural Requirements

The structural integrity of the job site is critical for a satisfactory flooring installation. The type and method of construction, grade level, and flooring system components all impact the installation of flooring products. Many times, local building codes establish only minimum requirements for flooring systems. These minimum requirements may not provide sufficient rigidity for successful installation and continued performance of flooring products. Hardwood, laminate, and porcelain flooring products require that the subfloor system is free of deflection.

Subfloor variations should not exceed  $\frac{1}{8}$ " in 6' (3.18 mm in 1.8 m). Use a 6' level or straightedge to check for variation. All high spots must be sanded or ground smooth. Fill in low spots, cracks, and depressions with Mannington MVP 2023 or equivalent.

## Radiant-Heated Subfloors

Mannington Laminate Flooring may be installed over hydroponic radiant-heated subfloors, provided the surface temperature of the system does not exceed 90°F. Before installing Mannington Laminate Flooring over newly constructed radiant-heating systems, operate the system at maximum capacity to force any residual moisture from the cementitious topping of the radiant heating system. Then set the thermostat to a comfortable room temperature for the installation.

## Existing Flooring Coverings

Mannington Laminate Floors can be installed over existing resilient floor coverings, wood flooring, and ceramic tile (grout joints must be leveled). Do not install Mannington Laminate Floors over carpet. Remove all carpet before proceeding with a Mannington Laminate Floors installation and examine the subfloor underneath. Make any repairs to the subfloor, if necessary, prior to installation.

## Whisper 3N1

Whisper 3N1 is a multi-use underlayment. It serves as a comfort, sound and moisture barrier. This new underlayment is thin, light and dense making it easier for installers to work with it on the job site.

Product specifications are as follows:

Thickness: 1 mm Roll weight: 6.5 lbs.

Roll size: 300 s.f. Pallet dimensions: 78" x 44" x 47"

Length: 50' Rolls per pallet: 60

Width: 72" Pallet weight: 471 lbs.

Roll diameter: 6"

Whisper 3N1 is available with or without connecting flaps. These flaps are designed to connect seams when a room requires more than one width of underlayment that is wider than 70". In order for the underlayment to act as a moisture barrier, the flaps must be used at any seam.

## Installation of Whisper 3N1 and AquaBarrier™

Whisper 3N1 and AquaBarrier II™ underlayment eliminates the need for a separate moisture barrier film and underlayment cushion. You will need one (1) roll of AquaBarrier II for every four (4) cartons of wood flooring installed. The amount of MegaGlue™ Adhesive required depends on the plank width being installed. Refer to MegaGlue™ Adhesive Requirements chart on page 71 for further details. Install AquaBarrier™ II by laying it out, poly side facing up. Seal all seams using the built-in edge sealing tape system. Tape any relief cuts or butt seams with duct tape.

## Laying and Fitting – Mannington Glueless Laminate Flooring

### General Instructions

Mannington “glueless” laminate floors are designed to be “floated.” That means they should never be nailed or glued to the subfloor. Glueless laminate planks are joined together by a specially designed mechanical locking profile; no adhesive is required to join the planks.

### Installation Procedure

Carefully measure the room to determine squareness and the width of the last row. If the width of the last row is determined to be less than 2" (50 mm), not including the bottom lip of the groove, the first row must be cut accordingly. Inspect each plank before installing. Closely inspect the edges of the plank to determine the tongue and groove profile. Remove any manufacturing residues from the tongue and groove before installing the plank. The factory-milled profiles of glueless laminate floors must always be removed when abutting a fixed vertical surface. This provides a full plank thickness at the juncture of the floor and walls. After determining the appropriate starting wall, remove the tongue of the first plank, and position this edge along the starting wall using  $\frac{5}{16}$ " spacers to maintain proper expansion gap. If the starting wall is irregular, the first row of planks must be scribed to fit.

Position one width of the appropriate Mannington Laminate underlayment along the starting wall. Always lay planks from left to right. In this procedure the tongue edge of the plank will be inserted into the groove, so it's important to lay out the first row with the tongue edge facing the starting wall. The last plank in the first row should be at least 12" (300 mm) long. If it is not, cut the first plank in the first row shorter to accommodate the required length of the last plank. Typically the remainder piece from the last plank may be used to start the next row; this plank should also be 12" (300 mm) or longer.

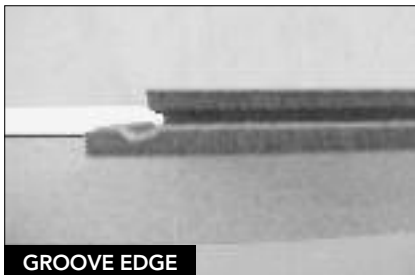

**GROOVE EDGE**  
Closely inspect the edges of the planks to determine the tongue and groove profile.

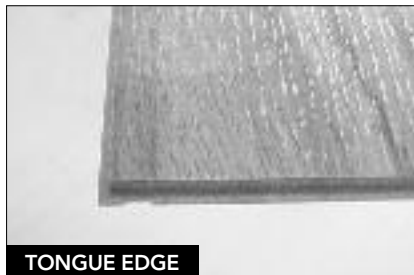

**TONGUE EDGE**  
In this procedure the tongue edge of the plank will be inserted into the groove, so it's important to lay out the first row with the tongue edge facing the starting wall.



Cut off all milled profiles from the edges abutting vertical surfaces. This provides a solid edge to receive spacing devices.



Job layout and determining an appropriate starting point is also very important with glueless laminate installations. The installation should be “balanced” with nearly equal panel widths at the sides and no panels shorter than 12" at the length walls. Sometimes it is advantageous to start the installation in areas that would be difficult to tilt in the last row, for example under cabinets, door casings, etc.

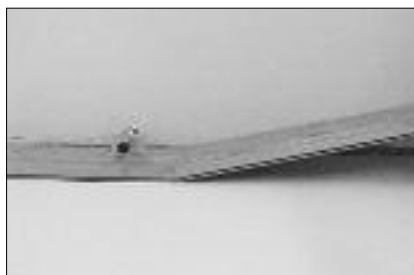

With the panel properly prepared, always lay planks from left to right, groove profile facing away from the wall. To join the second plank in the first row to the first plank, position the tongue end over the groove end of the first plank and insert the tongue at a slight angle. A slight downward “wiggle” motion locks the planks.



Begin second row with at least 12" stagger of end joints, assemble the first panel in the second row to the adjacent panel in the first row by slightly angling tongue into groove until plank locks into position. Insert the tongue at about a 20° angle and lock the planks together. (Use non-marring blue tape to secure the panel across the assembled joint to hold it in place.)

## Laminate Flooring Installation Guide (continued)



Position the end tongue of the second plank over the first plank in the second row, approximately 1/8" to 1/4" away from the side groove. Lock the end seam together. Always lock the end ("head") seams together before connecting sides seams.



Slightly angle the side tongue profile of this panel into the side groove of the panels in the first row, and with a slight wiggling action, press tongue into groove and lower into position. (The tape will secure the previously assembled panels together.) If necessary, tap with the heel of your hand to close any minor gaps.

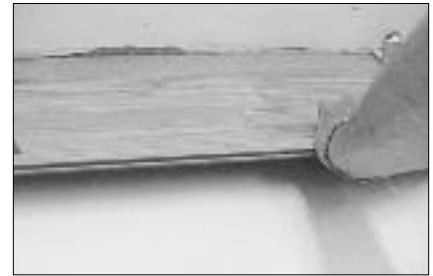

Continue to lay the flooring from left to right, row after row.



The last row of panels will more than likely need to be cut to fit. If not, it is still necessary to cut off the groove profile to provide a full plank thickness at the wall. If nothing prevents angling this last row of planks into position, proceed as normal to complete the installation.



If there are obstacles (door casings, toe kicks, radiators) that prevent the last row panels from being angled into position, it is necessary to lightly plane or sand off a bit of the locking profile of the groove and tongue.



PLANING OF TONGUE



Position the panel onto the already installed row; slide the panel under the obstruction. It's a good practice to pre-fit the panel to make certain it will slide back into place before applying adhesive.



Separate the panels to completely expose the groove. Apply a light coat of Mannington MegaGlue™ onto the groove; slide the last row panel back into position. If necessary, use a last board puller to position the panel and lightly tap panel to close any gap. Wipe off any excess glue.

## Laminate Flooring Installation Guide (continued)

### Pipes, Pillars and Posts

Installing flooring around pipes, pillars, and posts is easy if the following directions are used. Remember, you still must maintain the  $\frac{5}{16}$ " expansion gap around all of these obstacles.



First measure the diameter of the obstacle. Then measure that distance from the edge of the plank to be installed around the obstacle so you know where to drill the hole. Drill holes in the floor plank  $\frac{5}{8}$ " larger in diameter than the obstacle and the correct distance from the edge of the plank. If the hole is near the edge of the plank, cut the plank at a 45° angle to both sides of the hole.



If the hole is near the center of the plank, cut perpendicular to the long edge, going directly through the middle of the hole.



Now you will have two separate plank pieces to enable positioning around the obstacle. Apply a liberal amount of MegaGlue™ adhesive to the cut pieces and press into place. Tighten with a pull bar and wipe away excess adhesive with a clean, damp cloth.

### Installation Instructions for Wet Areas

(Bathrooms, Laundry Rooms, and Utility Rooms)

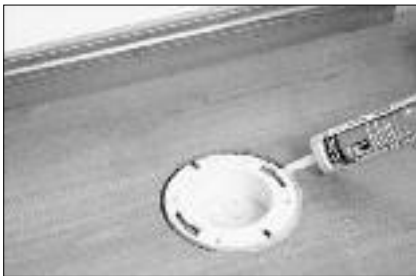

When installing laminate planks in a bathroom, remove the toilet and fit flooring to within  $\frac{5}{16}$ " of the toilet flange. Fill this expansion gap with high-quality silicone caulk.



To finish installations in a high-humidity or wet environment, the expansion gaps at all vertical surfaces such as walls, cabinets, etc., must be filled with high-quality silicone caulk.



Install Quarter Round moldings directly into the wet silicone caulk.



Install T-Moldings and Wall Base over the silicone caulk-filled expansion gaps. Nail Wall Base directly into the wall, not into the laminate flooring. Fill the expansion gap between planks and tub with a high-quality silicone caulk then install the profile into the wet silicone. In areas where a square edge profile cannot be installed, completely fill the  $\frac{5}{16}$ " expansion gap with silicone caulk.



**NOTE:** Use Mannington End Cap moldings against bathtubs and shower stalls when possible.

### Repairs – Mannington Laminate Floors

Although Mannington Laminate Floors are inherently tough, they can be accidentally chipped by falling objects. Always inspect each plank closely before installation; however, if damage occurs after installation, use the following repair procedures.

#### Mannington Laminate Repair Sealant

Mannington Laminate Repair sealant is a color-matched compound that is used to repair small nicks and chips. The sealant is applied to the damaged area to fill the void and the excess is removed with a dry cloth.

#### Plank Replacement for Glueless Laminate

Although the traditional method of plank replacement can be used with Mannington glueless laminate products, it is often easier and quicker to simply disassemble the planks back to the damaged area. Determine the closest wall to the repair area and remove the molding. Lift up to disengage tongue and groove of the planks and unlock the planks. Install a conditioned plank to replace the damaged one and reassemble the flooring. Replace trim molding.

#### Floor Care Maintenance Instructions

Mannington Laminate Floors are the closest thing to “maintenance-free” floors. The melamine-impregnated surface with aluminum oxide makes it resistant to dirt and scratches.

- Ordinary vacuuming with a non-beaterbar vacuum or sweeping is usually sufficient to keep the floor clean. If needed, an occasional cleaning with a cloth or mop (microfiber or terry cloth hooded) slightly moistened with Mannington UltraClean® is recommended.
- Never flood the floor with water.
- Do not use soap-based detergents because these can leave a dull finish on your floor.
- Do not use abrasive cleaners, steel wool, or scouring powder because these can scratch your floor.



**IMPORTANT: Never wax, polish, sand, or lacquer Mannington Laminate Floors.**

- Use doormats outside each entrance to your home to prevent dirt, sand, grit, and other substances such as oil, asphalt, and driveway sealer from being tracked onto your floor.
- For increased indentation resistance, use wide-bearing, non-staining floor protectors – such as clear hard plastic or non-staining felt protectors – for heavy furnishings.

## Laminate Flooring Installation Guide (continued)

### Moldings – Mannington Laminate Floors

Finish your installations with our seven choices of moldings. Manufactured to coordinate with our line of laminate floors, Mannington Laminate Wrapped Moldings will enhance the appearance of any installation. Refer to the illustrations and descriptions below for the proper use of each molding.

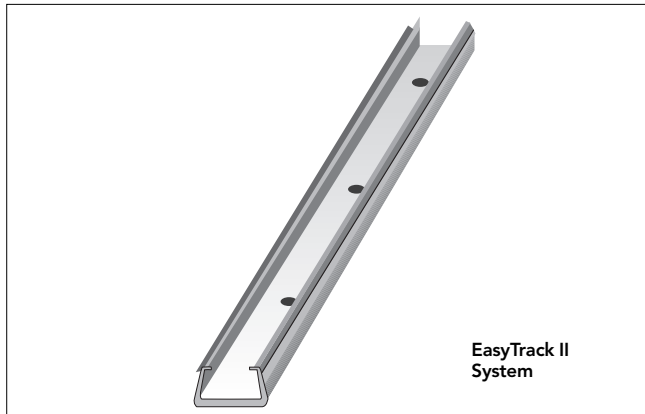

Use EasyTrack™ II System with T-Moldings and Reducer Strip moldings. Fasten EasyTrack™ II to the subfloor using either the supplied screws or construction adhesive. To use supplied screws, simply screw directly into wood subfloor or into concrete subfloors that have been drilled and plugged with dowels or plastic anchors. When using adhesive, allow it to fully cure before permitting foot traffic. The EasyTrack™ II System is included with all T-Molding and Reducer Strips.

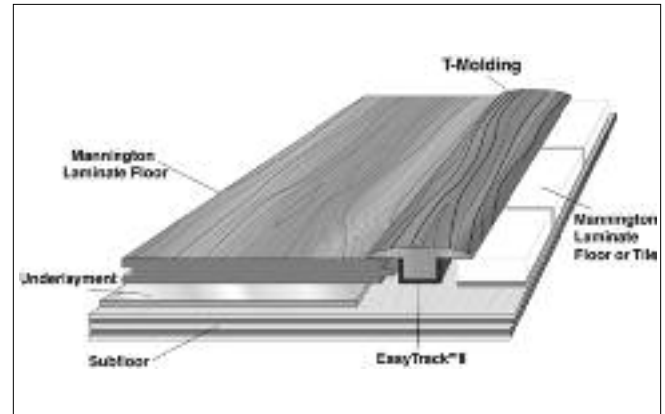

T-Molding is used in doorways or thresholds where it is necessary to join two sections of laminate flooring. It can also be used when an expansion joint is needed for covering large areas (plank length and/or width exceeding 30', or more than 900 sq. ft.). Additionally, T-Molding can be used to transition laminate floors to other flooring materials with similar heights, such as ceramic tile or hardwood. Leave a full 1-1/8" space between laminate planks (or between laminate planks and other flooring) to allow a sufficient amount of space for EasyTrack™ II and the required 5/16" expansion gap on each side of the EasyTrack™ II.

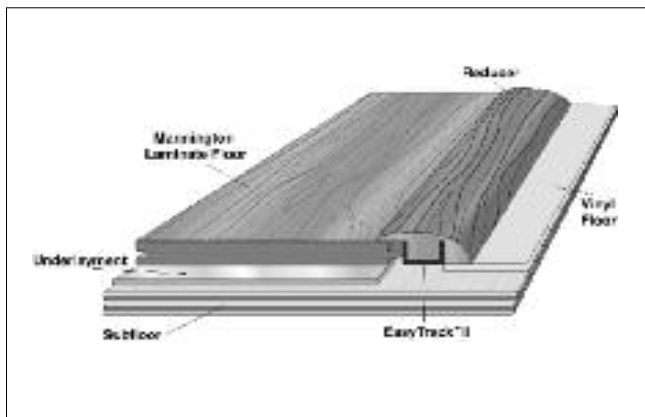

Reducers are used to join laminate flooring with other types of flooring lower in height, such as sheet vinyl or low pile carpet. A 1-1/2" space is required between laminate plank ends and the edge of the Reducer Strip to allow for the 5/16" expansion gap. EasyTrack™ II and screws are included.

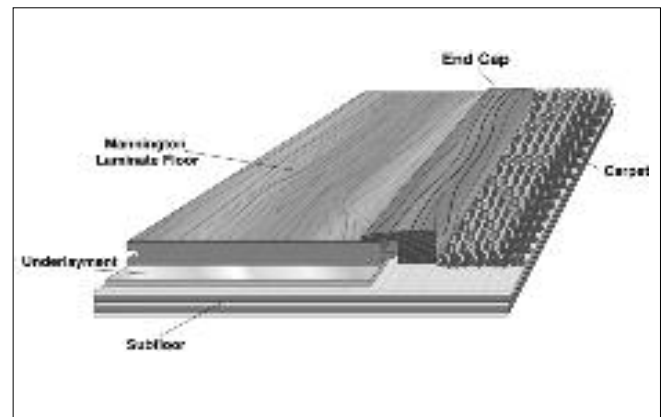

End Caps are typically used at exterior doorways to finish the space where the laminate floor ends, or any other place to give a finished appearance. They can also be used to join the laminate floor to another type of floor, such as carpet. Install End Caps against any vertical surface, with construction adhesive or finishing nails. If you choose to nail End Caps, first pre-drill holes. When using adhesive, allow the adhesive to fully cure before allowing foot traffic. An 11/16" space is required between plank ends and all vertical surfaces to meet the proper expansion space.

## Laminate Flooring Installation Guide (continued)

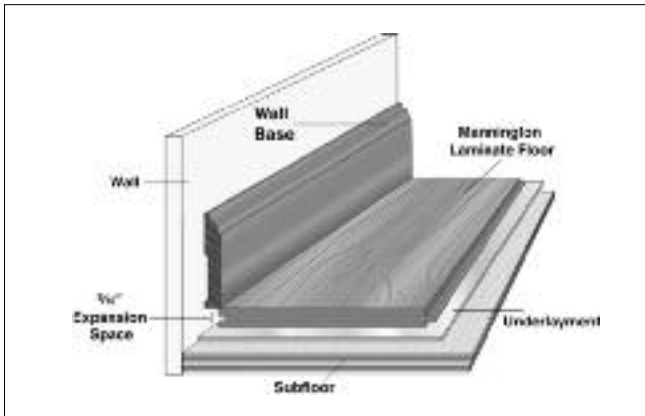

Wall Base covers the required 5/16" expansion gap to help join and blend the juncture of the new laminate flooring with the wall. Always fasten Wall Base into the wall, not into the flooring. When nailing Wall Base, first pre-drill holes. Use with or without Quarter Round.

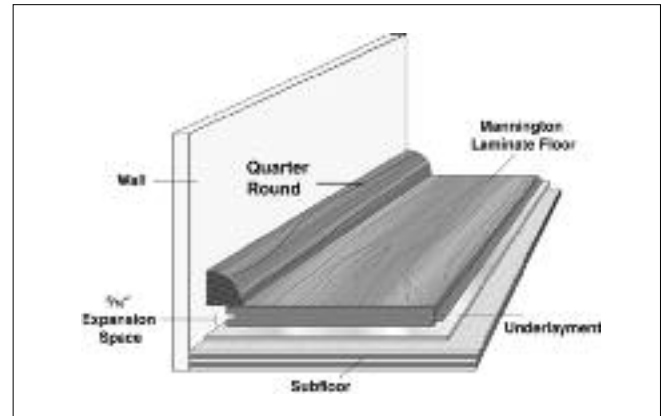

Quarter Round covers the required 5/16" expansion space to help join and blend the juncture of the new laminate flooring with the wall. Always nail Quarter Round into the wall, not into the flooring. When nailing, first pre-drill holes. Use with or without Wall Base molding.

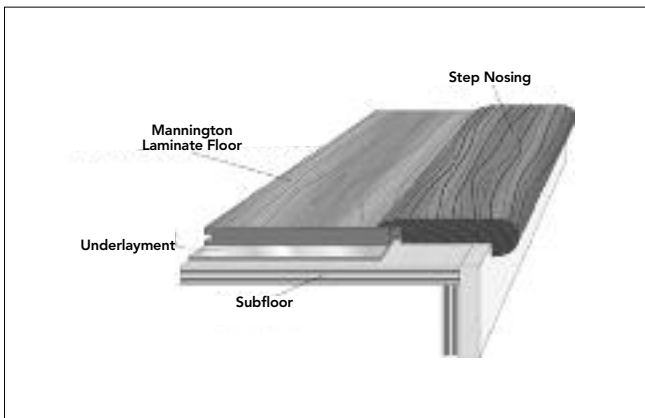

Step Nosing adds a finished look to laminate floors where subfloors change one level, such as a sunken family room. When nailing Step Nosing, first pre-drill holes. When using construction adhesive, let it fully cure before allowing foot traffic. A 1-1/4" space is required between plank ends and the edge of the stair riser to allow for the 5/16" expansion gap.

## The NatureForm® Tile Collection

### General Instructions

The NatureForm Tile Collection is designed to be installed using the “floating” floor system. This means that the panels are not secured to the subfloor; rather each panel joint is glued to the next, creating a strong, continuous surface. (Please check the product to be sure it is the “glued” version and not the new “click” NatureForm Tile product.)

NatureForm Laminate Tile is uniquely designed to provide a realistic ceramic tile visual. Each panel contains either three tiles (large slate/stone collection) or 12 tiles (small slate/stone collection), including grout lines, which allows for larger panel dimensions. Each panel is 15¾" wide by 47½" long. The depth and dimension of tile designs and grout lines, combined with realistic embossing, gives The NatureForm Tile Collection the realistic look of ceramic tile, with the benefits of laminate flooring.

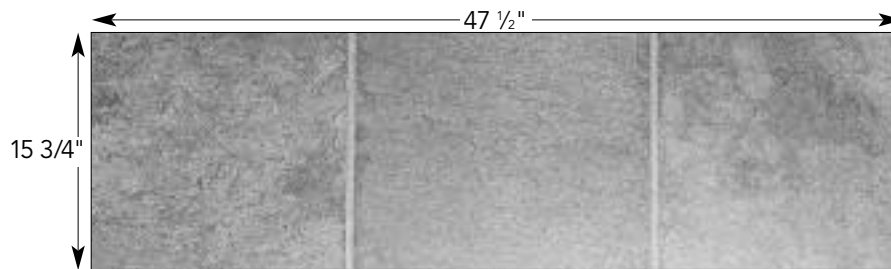

### Storage & Handling

Always store cartons horizontally on a fully supported flat surface. Do not stack pallets more than two high. Protect packages from forklift or other traffic. Also, during storage, carefully protect package corners and lay boxes horizontally. The storage area must be climate-controlled with a temperature range between 65°F and 90°F (18°C and 32°C) and a relative humidity not exceeding 65%.

### Job Site Conditions

Condition the unopened cartons in the area where the floor will be installed for approximately 48 hours. Job site temperature should be 65°F or higher with a relative humidity not to exceed 65%.

As with all flooring installations, the job site must be climate-controlled. Never install laminate tiles in high-humidity areas where the floor is usually wet (steam rooms and saunas).

If the job site has a panel length or width of more than 30', additional expansion joints will be required. Mannington T-Moldings should be used.

### Subfloor/Underfloor Recommendations & Preparation

The NatureForm Tile Collection can be installed over all structurally sound wood or concrete subfloor systems on all grade levels. Subfloors must be clean and free of debris. The subfloor must also be smooth and flat to within ¼" ≤ per 10' span. All low spots must be filled with a high-quality cementitious compound, like Mannington MVP 2023, and all high spots must be removed by sanding or grinding.

Tiles can be installed over existing hard surface floor coverings. Heavily textured ceramic tile must be smoothed and leveled with MVP 2023.

NatureForm Laminate Tile may be installed over radiant-heated subfloors provided that the surface temperature of the in-floor heating system does not exceed 90°F.

# Laminate Flooring Installation Guide (continued)

## Wall Base Removal & Installation Preparation



Carefully remove all existing wall base, trim, and transition moldings using a pry bar.



Measure out the entire work area to ensure proper panel layout. Keep in mind the last panel to be laid in the work area must be at least 3" wide. A calculator may be helpful when figuring out how to arrange the floor. A NatureForm Laminate Tile panel measures 15-3/4" wide.

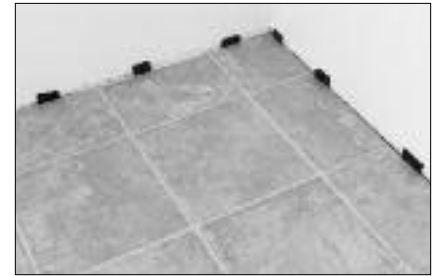

As with all tile formats, the best appearance is achieved by "balancing" the tiles at both the end and side walls. This can be accomplished by finding the centerline of the work area and adjusting the panels to provide equal size tiles at all walls.

## Getting Started



NatureForm Tiles must be installed over a Mannington Laminate underlayment such as AquaBarrier™ II, ComfortBarrier™ or Mannington® Hush. If you elect to use the Hush underlayment, be certain to take into account the additional thickness when undercutting door casings. Use a scrap piece of the new NatureForm Tile flooring as a guide. Be certain to allow enough room under

the casing for a 5/16" expansion gap. Lay the panel face down over a sheet of Mannington Hush and against the frame to act as a cutting guide. Make the cut using a hand or power jamb saw and simply slide the panel underneath the door casing.



**NOTE:** NatureForm Tiles are intended to be installed as a floating floor system. Never secure flooring to the underfloor with nails, glue, or screws.

## Laying & Adhering



After careful planning and layout, begin by dry-laying the first row. Always work from left to right in the installation area and against the tongue side of the panel with the groove edge facing the wall. Whenever possible, avoid working directly on top of the panels because damage may occur. Maintain an expansion gap of 5/16" by using spacing wedges in the corners and where panels join together. If the starting wall is irregular, the first row must be scribed, cut, and fit to the contour of the wall.



The tile panels can be cut using traditional cutting tools such as hand saws, jig saws, circular saws, power miter or chop saws, etc. The wide panel width of NatureForm Tile can be effectively cut to length using a table saw.

## Laminate Flooring Installation Guide (continued)



**NOTE:** Establish an area away from the work area for cutting and utilize "dust" containment systems when cutting. Keep the debris created during cutting out of the work area.



Stagger the end joints of the second row by at least one full tile pattern. Carefully align the grout lines on the panels. Pay particular attention to tile pattern repeats. Lay out panels so repetitive tile designs are not clustered.

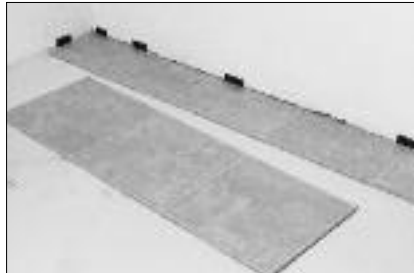

Continue to dry-lay the first two rows of the tile panels as a trial layout, using spacing wedges to provide the required 5/16" expansion gap. Check each panel's alignment to be certain all panels are straight and both along the length and across the width.

### Last Row Installation



The last row of tile panels should be the same width as the first row. To scribe the last row of panels into place accurately, align the panel over the last installed row of panels and scribe to fit. Be certain to provide the required expansion gap.



Saw each panel in the last row accordingly and fit them into place using the pull bar. Then add the spacing wedges to hold the joints firmly in place and to create the required expansion gap between these last panels and the wall.

If installing NatureForm Laminate Tiles into a bathroom, always remove the toilet. Fit the panel to within  $\frac{5}{16}$ " of the toilet flange. Fill this and all other expansion gaps with a high-quality silicone caulking compound. Any time NatureForm Tiles are installed in an area that may become wet, the expansion gap must always be filled with a high-quality silicone caulk.

When fitting around pipes, pillars, or columns, always provide a  $\frac{5}{16}$ " expansion gap.

### Floor Care Maintenance

Follow same procedures as recommended on page 85.

# Laminate Flooring Installation Guide (continued)

## Technical & Packaging Information

### Packaging – Revolutions™ Plank

	Board	Thickness	Width	Length	Weight	Sq Ft	Cartons
Plank	1	5/16"	55/16"	501/2"	2.97 lbs	1.85	—
Carton	12	4"	55/16"	513/8"	35.7 lbs	22.24	1
Pallet	588	275/8"	54"	42"	1,749 lbs	1,090.0	49

### Packaging – Revolutions™ Tile

#### Adirondack

	Board	Thickness	Width	Length	Weight	Sq Ft	Cartons
Plank	1	5/16"	153/4"	503/4"	8.04 lbs	5.52	—
Carton	4	11/2"	161/4"	515/8"	32.15 lbs	22.11	1
Pallet	224	392/3"	321/2"	515/8"	1,800.53 lbs	1,237	56

### Packaging – All Other Revolutions™ Tile

	Board	Thickness	Width	Length	Weight	Sq Ft	Cartons
Plank	1	5/16"	123/4"	503/4"	7.07 lbs	4.46	—
Carton	5	13/4"	133/8"	515/8"	35.35 lbs	22.32	1
Pallet	270	311/4"	40"	515/8"	1,909.05 lbs	1,205.34	54

### Packaging – NatureForm® Tile Collection\* and Valu Tile

	Board	Thickness	Width	Length	Weight	Sq Ft	Cartons
Plank	1	5/16"	153/4"	471/8"	7.5 lbs	5.15	—
Carton	4	11/2"	165/16"	481/8"	30 lbs	20.61	1
Pallet	224	392/3"	325/8"	481/8"	1,680 lbs	1,154	56

### Packaging – Coordinations™

#### Coordinations and Value Lock

	Board	Thickness	Width	Length	Weight	Sq Ft	Cartons
Plank	1	5/16"	77/16"	501/2"	4.20 lbs	2.65	—
Carton	8	25/8"	81/8"	513/8"	33.60 lbs	21.21	1
Pallet	400	263/4"	401/2"	513/8"	1,680 lbs	1,061	50

## Molding Tips

- Before installing the first plank, select a dozen or more planks that closely blend with the molding.
- All Laminate Wrapped Molding Strips and Easy Track II come in 94" long pieces.
- Quarter Round, Wall Base, Step Nosing and End Caps are not available with Easy Track II System.
- Reducer Strips and T-Moldings include aluminum track screws and may be installed with or without the Easy Track II system.